

Vehicle power charger for SUV-Cam

Instruction manual

Please read this instruction manual and instruction manual for SUV-Cam carefully before using this product and keep it for future reference.

Important safeguards

Please make sure to follow all instructions when you use the charger. These "Important safeguards" are provided to ensure proper operation of the product and will prevent you or others from personal injury or loss of assets. Please read carefully and keep the manual in a safe place for future reference. Review the following symbols so that you understand them before reading the rest of the manual.

 **Warning** Ignoring this warning and operating the system incorrectly subjects the user to possible risk of serious injury or death.

 **Caution** Ignoring this warning and operating the system incorrectly subjects the user to possible risk of injury or loss of assets.

● Explanation of the Symbols Used

 **Name** : Prohibition
Explanation : The user must avoid these actions or be exposed to danger. Nearby text and illustrations give further details.

 **Name** : Must follow
Explanation : The user must follow the instructions. Nearby text and illustrations give further details.

 **Warning**

 For your safety
 Connect the unit before driving. Do not place the SUV-Cam series/recorder where it may interfere with safe driving.

 Do not attach the unit where it will interfere the operation of air bag system. The air bag system may not function properly if you attach the unit near the system. It may injure passengers.

 Do not place or wire the unit in such a way that it will interfere with driving or operating the vehicle. It may cause accident, electric shock or fire.

 Do not attach the unit in high humidity or dusty area
 It may cause fire or electric shock.

 Do not attempt to modify the product.
 User modification could cause fire or electric shock and personal injury.

 Do not cover the unit while in use.
 The heat build-up may result in deformation or fire.

 Do not expose the unit to abnormally high temperature, such as direct sunlight or a vehicle interior with the windows rolled up in summer.
 These conditions may cause deformation or defect.

 Do not allow water or any foreign object to enter the unit.
 It may cause fire or electric shock.

 Do not use the unit with other equipments than SUV-Cam series.
 It may cause fire or electric shock.

 **Caution**

 Do not hold or touch the unit for a long time while charging.
 It may cause low-temperature burn.

Precautions

- After using the unit, be sure to pull it out of the power outlet.
- When pulling it out of the power outlet, be sure to hold the unit.
- When the contact part of the unit is touched on metal, it may be short-circuited.
- Do not start or turn off the engine with the unit connected to the power outlet. The data in memory card of the SUV-Cam series/recorder may be destroyed or deleted.
- Do not attempt to use the unit in vehicles with DC24V electrical systems, with positive ground electrical systems or with non-matching power outlet.

Features

- The unit can supply the power to the SUV-Cam series/recorder from the power outlet of a vehicle.
- The LED indicator shows that the unit is working.

How to use

 Connect the unit after starting an engine. Do not turn off the engine with the unit plugged into the power outlet and the SUV-Cam. Under these conditions, the car battery may be consumed.

1. Insert the unit into the power outlet.
LED indicator comes on.

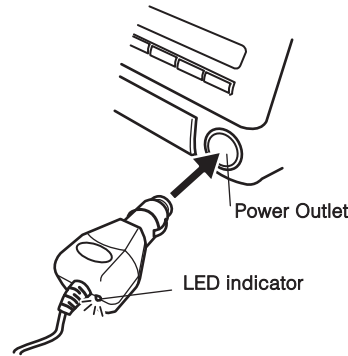

2. Remove a DC jack cover of SUV-Cam series/recorder and insert the unit into the DC jack.
Remove a DC jack cover on the left side of the recorder.

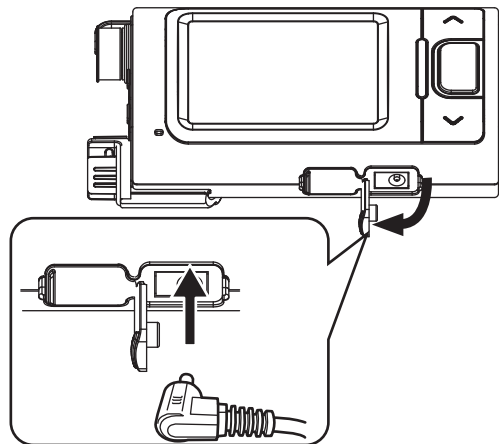

● **SPECIFICATIONS**

Rated input voltage : DC12V dedicated (Negative ground systems only)
 Rated output voltage : DC5V
 Rated output current : Approx. 1A
 Operating temperature : -10°C ~ 45°C
 Weight : Approx. 60g
 Dimension : 86 (W) x 40 (D) x 30 (H) (Main unit only. Not including cable.)
 Cable length : Approx. 1.2m

※The design and specifications are subject to change without prior notice.

ELMO CO., LTD.

ELMO are trademarks and/or registered trademarks of ELMO Co., Ltd.

URL: <http://www.elmo.co.jp>